

Product Category

H854-04-08-M

Part Description

Tube to Male Pipe Thread Union Assembly

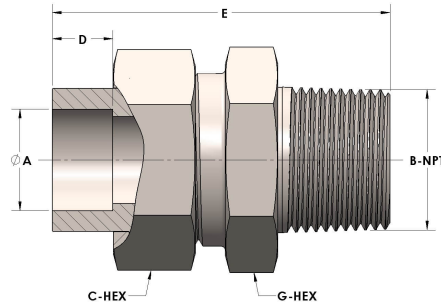

DIMENSIONS

A	0.250
B-NPT	1/2" - 14
C-HEX	0.94
D	0.190
E	1.94
G-HEX	0.88

GENERAL

Pressure Rating	6000 PSI
Assembly Material	Monel®, ASTM B164, UNS N04405
O-Ring Material	Viton® Fluorocarbon Type 1, Class 2 (90 durometer)
Connection 1 Type	Female Tube Socket
Connection 1 Size	1/4" Tube O.D. (-04)
Connection 2 Type	Male Pipe Thread
Connection 2 Size	1/2" NPT (-08)