

Product Category

H854-08-08-S

Part Description

Tube to Male Pipe Thread Union Assembly

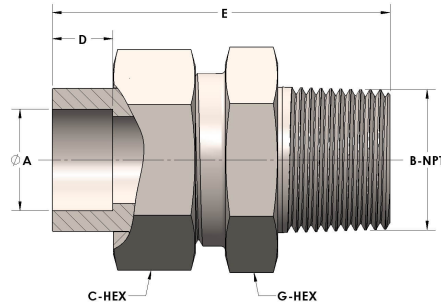

## DIMENSIONS

A	0.500
B-NPT	1/2" - 14
C-HEX	0.94
D	0.310
E	2.06
G-HEX	0.88

## GENERAL

Pressure Rating	4500 PSI
Assembly Material	Carbon Steel, ASTM A108
O-Ring Material	Viton® Fluorocarbon Type 1, Class 2 (90 durometer)
Connection 1 Type	Female Tube Socket
Connection 1 Size	1/2" Tube O.D. (-08)
Connection 2 Type	Male Pipe Thread
Connection 2 Size	1/2" NPT (-08)