

Product Category

H854-08-12-M

Part Description

Tube to Male Pipe Thread Union Assembly

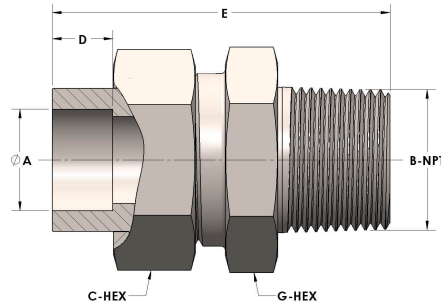

## DIMENSIONS

A	0.500
B-NPT	3/4" - 14
C-HEX	1.38
D	0.310
E	2.31
G-HEX	1.38

## GENERAL

Pressure Rating	6000 PSI
Assembly Material	Monel®, ASTM B164, UNS N04405
O-Ring Material	Viton® Fluorocarbon Type 1, Class 2 (90 durometer)
Connection 1 Type	Female Tube Socket
Connection 1 Size	1/2" Tube O.D. (-08)
Connection 2 Type	Male Pipe Thread
Connection 2 Size	3/4" NPT (-12)