

Product Category

H854-12-12-M

Part Description

Tube to Male Pipe Thread Union Assembly

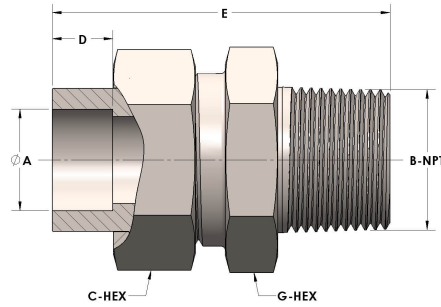

DIMENSIONS

| | |
|-------|-----------|
| A | 0.750 |
| B-NPT | 3/4" - 14 |
| C-HEX | 1.38 |
| D | 0.440 |
| E | 2.44 |
| G-HEX | 1.38 |

GENERAL

| | |
|-------------------|--|
| Pressure Rating | 6000 PSI |
| Assembly Material | Monel®, ASTM B164, UNS N04405 |
| O-Ring Material | Viton® Fluorocarbon Type 1, Class 2 (90 durometer) |
| Connection 1 Type | Female Tube Socket |
| Connection 1 Size | 3/4" Tube O.D. (-12) |
| Connection 2 Type | Male Pipe Thread |
| Connection 2 Size | 3/4" NPT (-12) |