

Product Category

H863-08-M

Part Description

Socketweld/braze Tube to Male Tube Union Assembly

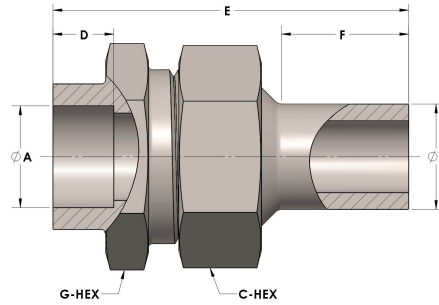

DIMENSIONS

A	0.500
B	0.50
C-HEX	0.94
D	0.310
E	1.94
F	0.69
G-HEX	0.88

GENERAL

Pressure Rating	6000 PSI
Assembly Material	Monel®, ASTM B164, UNS N04405
O-Ring Material	Viton® Fluorocarbon Type 1, Class 2 (90 durometer)
Connection 1 Type	Female Tube Socket
Connection 1 Size	1/2" Tube O.D. (-08)
Connection 2 Type	Female Tube Socket
Connection 2 Size	1/2" Tube O.D. (-08)