

Product Category

H863-12-S

Part Description

Socketweld/braze Tube to Male Tube Union Assembly

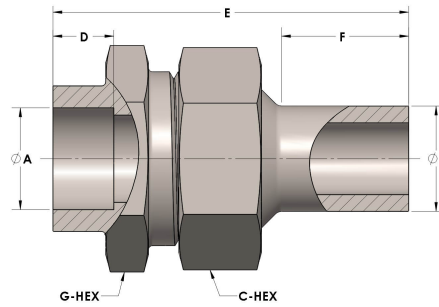

DIMENSIONS

A	0.750
B	0.75
C-HEX	1.38
D	0.440
E	2.56
F	0.94
G-HEX	1.38

GENERAL

Pressure Rating	4500 PSI
Assembly Material	Carbon Steel, ASTM A108
O-Ring Material	Viton® Fluorocarbon Type 1, Class 2 (90 durometer)
Connection 1 Type	Female Tube Socket
Connection 1 Size	3/4" Tube O.D. (-12)
Connection 2 Type	Female Tube Socket
Connection 2 Size	3/4" Tube O.D. (-12)