

Product Category

H863R-04-M

Part Description

Male Tube Weld Tailpiece

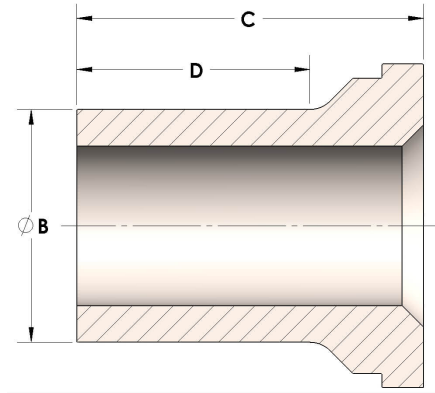

DIMENSIONS

B	0.25
C	0.81
D	0.560

GENERAL

Pressure Rating	6000 PSI
Tailpiece Material	Monel®, ASTM B164, UNS N04405