

Product Category

H863R-12-SS316L

Part Description

Male Tube Weld Tailpiece

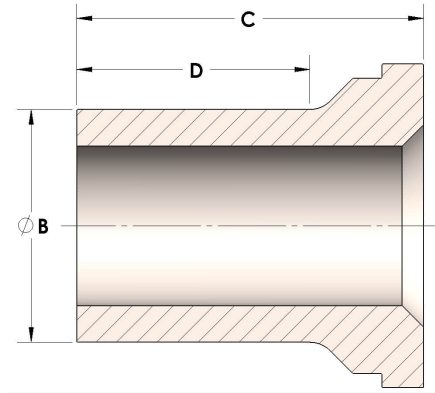

DIMENSIONS

B	0.75
C	1.31
D	0.940

GENERAL

Pressure Rating	6000 PSI
Tailpiece Material	316/L Stainless Steel, ASTM A276, UNS S31600/03