

Product Category

H863R-20-M

Part Description

Male Tube Weld Tailpiece

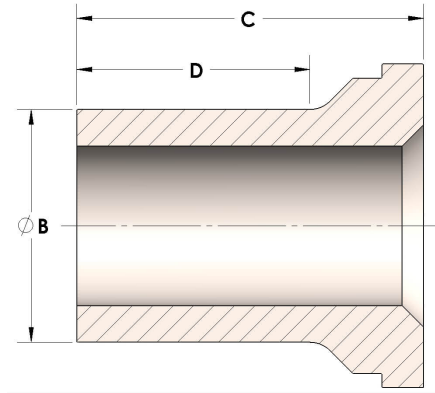

## DIMENSIONS

<b>B</b>	1.25
<b>C</b>	1.69
<b>D</b>	1.250

## GENERAL

<b>Pressure Rating</b>	4500 PSI
<b>Tailpiece Material</b>	Monel®, ASTM B164, UNS N04405