

Product Category

H863R-20-S

Part Description

Male Tube Weld Tailpiece

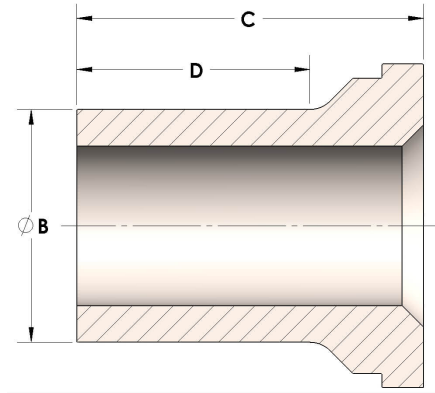

DIMENSIONS

B	1.25
C	1.69
D	1.250

GENERAL

Pressure Rating	3000 PSI
Tailpiece Material	Carbon Steel, ASTM A108