

Product Category

H863R-32-M

Part Description

Male Tube Weld Tailpiece

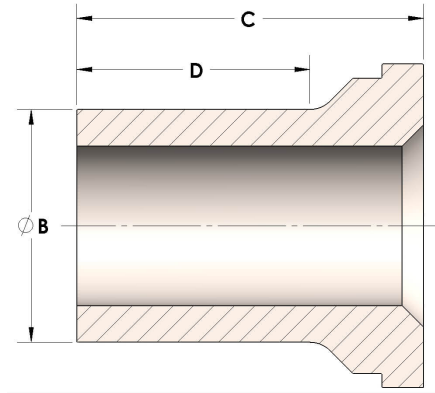

DIMENSIONS

B	2.00
C	2.25
D	1.560

GENERAL

Pressure Rating	4500 PSI
Tailpiece Material	Monel®, ASTM B164, UNS N04405