

Product Category

H863R-32-SS316L

Part Description

Male Tube Weld Tailpiece

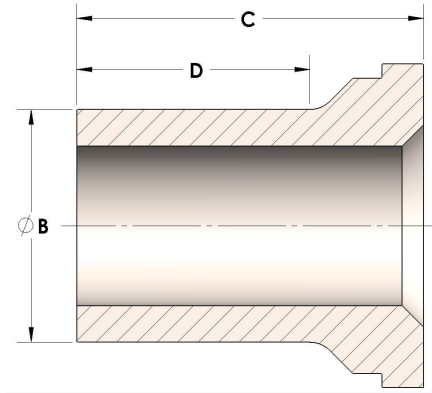

## DIMENSIONS

<b>B</b>	2.00
<b>C</b>	2.25
<b>D</b>	1.560

## GENERAL

<b>Pressure Rating</b>	3000 PSI
<b>Tailpiece Material</b>	316/L Stainless Steel, ASTM A276, UNS S31600/03