

Product Category

H865-04-04-CUNI

Part Description

Direct Weld/Braze Insert (Male Pipe X Tube SW)

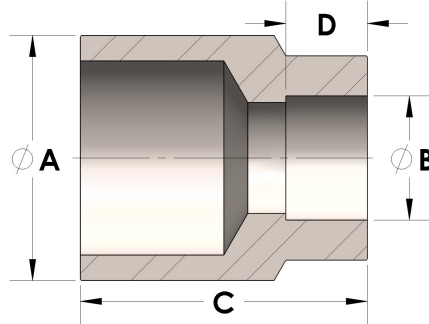

DIMENSIONS

A	0.540
B	0.25
C	0.75
D	0.190

GENERAL

Pressure Rating	6000 PSI
Fitting Material	Copper Nickel 70/30, MIL-C--15726F, UNS C71500