

Product Category

H865-06-08-SS316L

Part Description

Direct Weld/Braze Insert (Male Pipe X Tube SW)

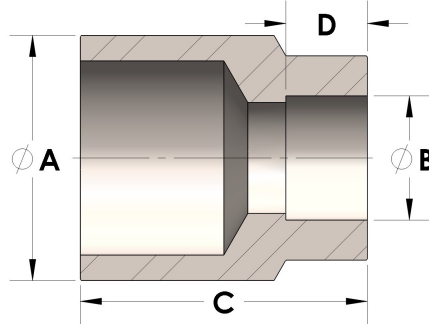

DIMENSIONS

A	0.675
B	5.00
C	0.88
D	0.310

GENERAL

Pressure Rating	4500 PSI
Fitting Material	316/L Stainless Steel, ASTM A276, UNS S31600/03