

Product Category

H865-06-10-SS316L

Part Description

Direct Weld/Braze Insert (Male Pipe X Tube SW)

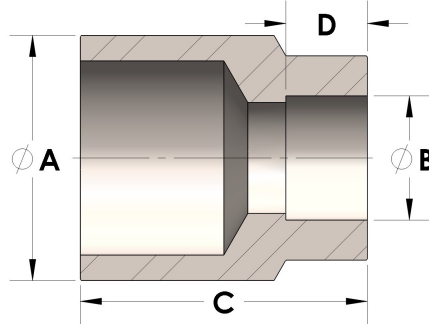

## DIMENSIONS

A	0.675
B	0.63
C	1.13
D	0.380

## GENERAL

Pressure Rating	6000 PSI
Fitting Material	316/L Stainless Steel, ASTM A276, UNS S31600/03