

Product Category

H865-08-04-S

Part Description

Direct Weld/Braze Insert (Male Pipe X Tube SW)

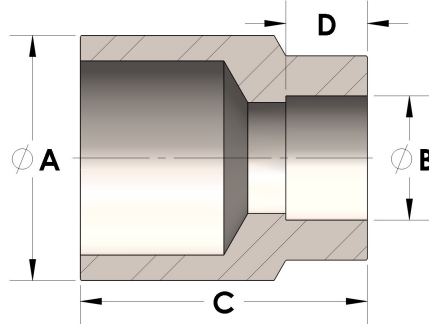

DIMENSIONS

A	0.840
B	0.25
C	1.00
D	0.190

GENERAL

Pressure Rating	6000 PSI
Fitting Material	Carbon Steel, ASTM A108