

Product Category

H865-08-12-S

Part Description

Direct Weld/Braze Insert (Male Pipe X Tube SW)

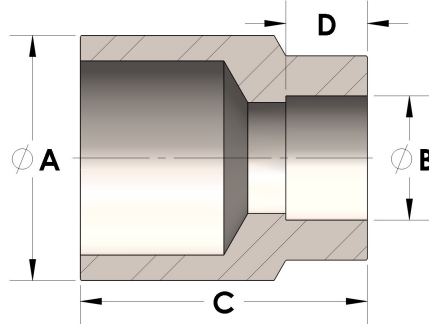

## DIMENSIONS

A	0.840
B	0.75
C	1.25
D	0.440

## GENERAL

Pressure Rating	6000 PSI
Fitting Material	Carbon Steel, ASTM A108