

Product Category

H865-12-08-CUNI

Part Description

Direct Weld/Braze Insert (Male Pipe X Tube SW)

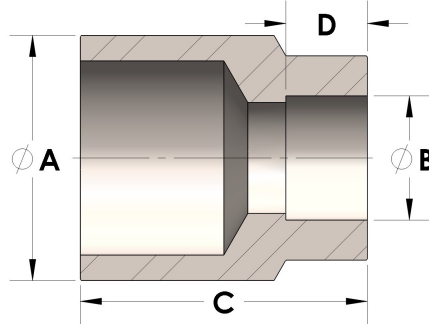

DIMENSIONS

A	1.050
B	0.50
C	1.25
D	0.310

GENERAL

Pressure Rating	3000 PSI
Fitting Material	Copper Nickel 70/30, MIL-C--15726F, UNS C71500