

Product Category

H865-20-08-S

Part Description

Direct Weld/Braze Insert (Male Pipe X Tube SW)

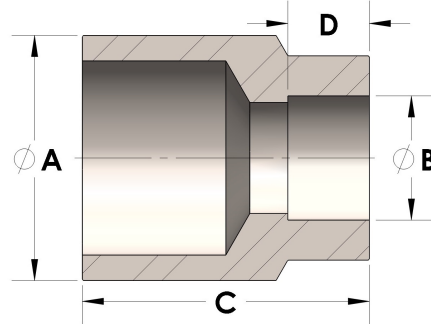

DIMENSIONS

A	1.660
B	0.50
C	1.63
D	0.310

GENERAL

Pressure Rating	4500 PSI
Fitting Material	Carbon Steel, ASTM A108