

Product Category

H865-24-16-CUNI

Part Description

Direct Weld/Braze Insert (Male Pipe X Tube SW)

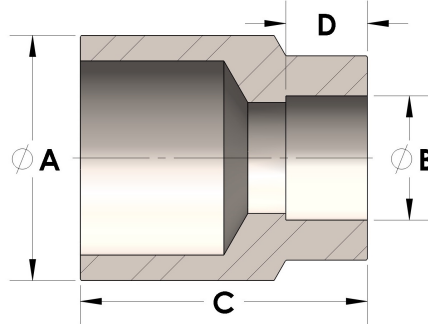

DIMENSIONS

A	1.900
B	1.00
C	1.75
D	0.500

GENERAL

Pressure Rating	2500 PSI
Fitting Material	Copper Nickel 70/30, MIL-C--15726F, UNS C71500