

Product Category

H865-32-16-SS316L

Part Description

Direct Weld/Braze Insert (Male Pipe X Tube SW)

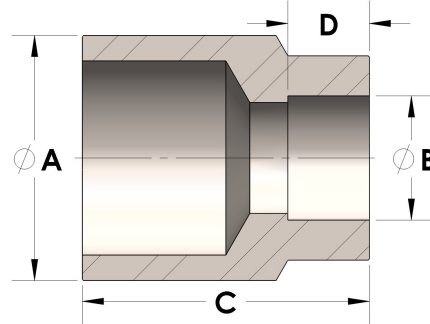

DIMENSIONS

A	2.375
B	1.00
C	2.00
D	0.500

GENERAL

Pressure Rating	3000 PSI
Fitting Material	316/L Stainless Steel, ASTM A276, UNS S31600/03