

Product Category

H866-06-04-S

Part Description

Direct Weld/Braze Insert (Male Tube X Pipe SW)

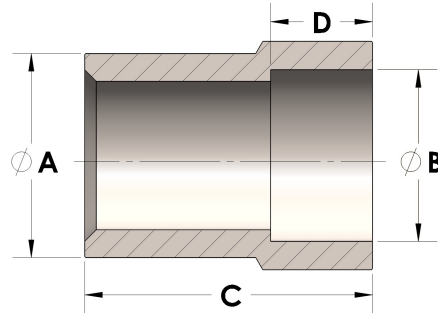

## DIMENSIONS

A	0.380
B	0.55
C	1.19
D	0.380

## GENERAL

Pressure Rating	4500 PSI
Fitting Material	Carbon Steel, ASTM A108