

Product Category

H866-08-02-S

Part Description

Direct Weld/Braze Insert (Male Tube X Pipe SW)

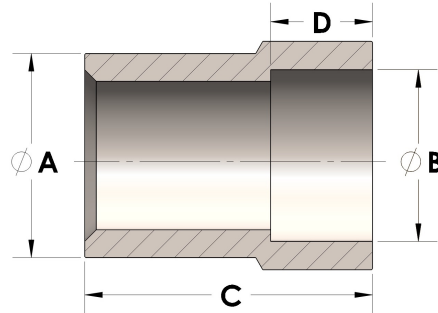

DIMENSIONS

A	0.500
B	0.41
C	1.19
D	0.380

GENERAL

Pressure Rating	6000 PSI
Fitting Material	Carbon Steel, ASTM A108