

Product Category

H866-10-04-SS316L

Part Description

Direct Weld/Braze Insert (Male Tube X Pipe SW)

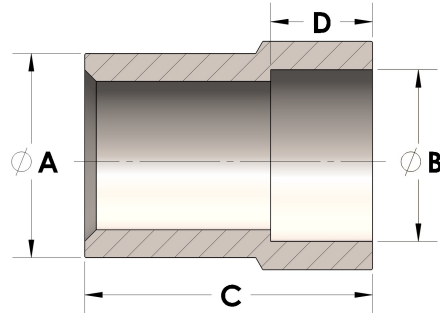

DIMENSIONS

A	0.630
B	0.55
C	1.19
D	0.380

GENERAL

Pressure Rating	4500 PSI
Fitting Material	316/L Stainless Steel, ASTM A276, UNS S31600/03