

Product Category

H866-16-08-CUNI

Part Description

Direct Weld/Braze Insert (Male Tube X Pipe SW)

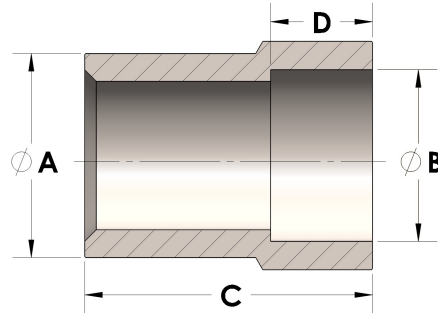

DIMENSIONS

A	1.000
B	0.85
C	1.38
D	0.380

GENERAL

Pressure Rating	2000 PSI
Fitting Material	Copper Nickel 70/30, MIL-C--15726F, UNS C71500