

Product Category

H866-20-12-S

Part Description

Direct Weld/Braze Insert (Male Tube X Pipe SW)

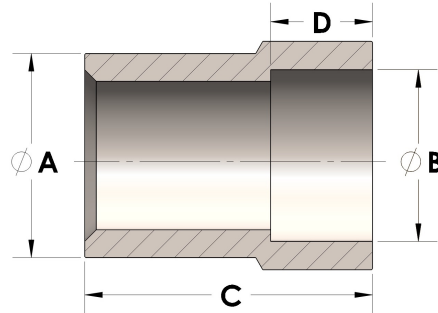

DIMENSIONS

A	1.250
B	1.06
C	1.75
D	0.500

GENERAL

Pressure Rating	4500 PSI
Fitting Material	Carbon Steel, ASTM A108