

Product Category

H866-20-20-S

Part Description

Direct Weld/Braze Insert (Male Tube X Pipe SW)

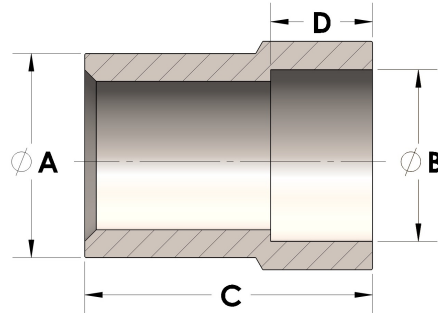

DIMENSIONS

A	1.250
B	1.67
C	2.00
D	0.500

GENERAL

Pressure Rating	3000 PSI
Fitting Material	Carbon Steel, ASTM A108