

Product Category

H866-24-12-SS316L

Part Description

Direct Weld/Braze Insert (Male Tube X Pipe SW)

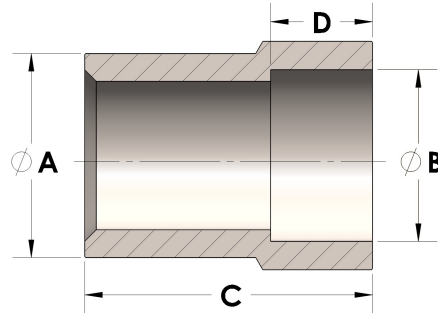

## DIMENSIONS

A	1.500
B	1.06
C	1.50
D	0.500

## GENERAL

Pressure Rating	3000 PSI
Fitting Material	316/L Stainless Steel, ASTM A276, UNS S31600/03