

Product Category

H866-24-24-M

Part Description

Direct Weld/Braze Insert (Male Tube X Pipe SW)

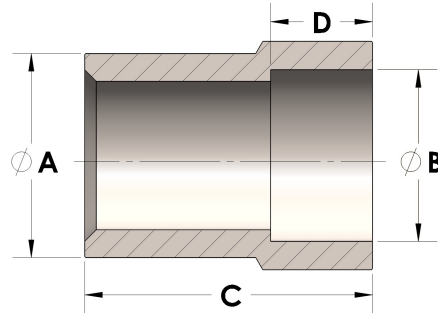

## DIMENSIONS

A	1.500
B	1.91
C	2.50
D	0.500

## GENERAL

Pressure Rating	4500 PSI
Fitting Material	Monel®, ASTM B164, UNS N04405