

Product Category

H866-32-32-M

Part Description

Direct Weld/Braze Insert (Male Tube X Pipe SW)

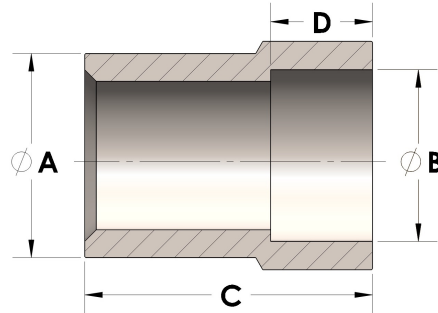

## DIMENSIONS

A	2.000
B	2.38
C	2.75
D	0.630

## GENERAL

Pressure Rating	4500 PSI
Fitting Material	Monel®, ASTM B164, UNS N04405