

Product Category

H866-32-32-S

Part Description

Direct Weld/Braze Insert (Male Tube X Pipe SW)

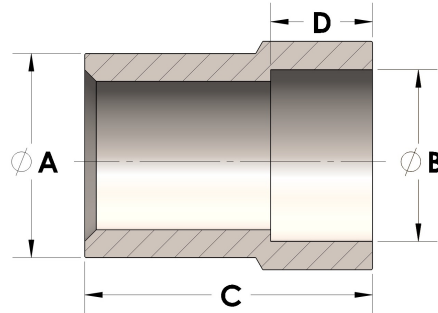

DIMENSIONS

A	2.000
B	2.38
C	2.75
D	0.630

GENERAL

Pressure Rating	3000 PSI
Fitting Material	Carbon Steel, ASTM A108