

Product Category

H867-10-06-CUNI

Part Description

Direct Weld/Braze Insert (Male Tube X Tube SW)

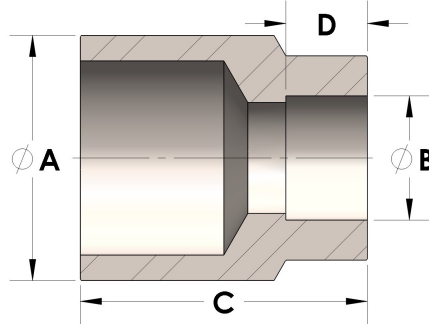

## DIMENSIONS

A	0.630
B	0.38
C	0.94
D	0.250

## GENERAL

Pressure Rating	4500 PSI
Fitting Material	Copper Nickel 70/30, MIL-C--15726F, UNS C71500