

Product Category

H867-12-06-S

Part Description

Direct Weld/Braze Insert (Male Tube X Tube SW)

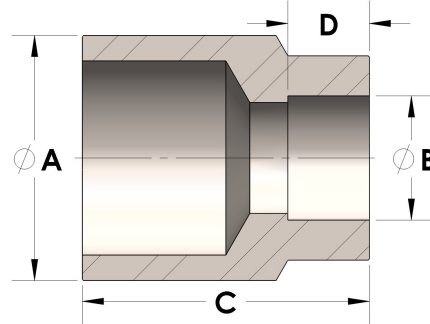

DIMENSIONS

A	0.750
B	0.38
C	0.88
D	0.250

GENERAL

Pressure Rating	3000 PSI
Fitting Material	Carbon Steel, ASTM A108