

Product Category

H867-16-10-S

Part Description

Direct Weld/Braze Insert (Male Tube X Tube SW)

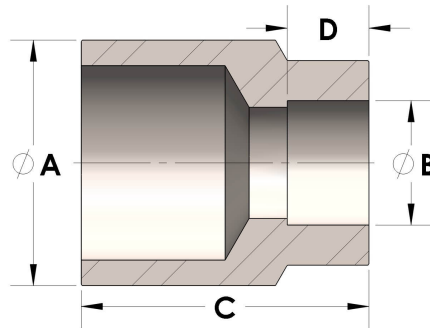

DIMENSIONS

A	1.000
B	0.63
C	1.06
D	0.380

GENERAL

Pressure Rating	3000 PSI
Fitting Material	Carbon Steel, ASTM A108