

Product Category

H867-20-12-SS316L

Part Description

Direct Weld/Braze Insert (Male Tube X Tube SW)

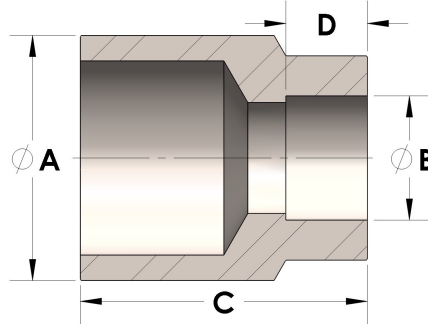

DIMENSIONS

A	1.250
B	0.75
C	1.25
D	0.440

GENERAL

Pressure Rating	4500 PSI
Fitting Material	316/L Stainless Steel, ASTM A276, UNS S31600/03