

Product Category

H867-24-06-CUNI

Part Description

Direct Weld/Braze Insert (Male Tube X Tube SW)

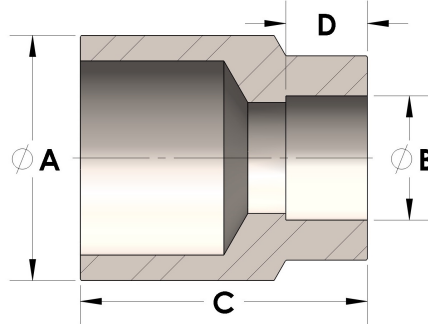

DIMENSIONS

A	1.500
B	0.38
C	1.38
D	0.250

GENERAL

Pressure Rating	2500 PSI
Fitting Material	Copper Nickel 70/30, MIL-C--15726F, UNS C71500