

Product Category

H867-24-06-SS316L

Part Description

Direct Weld/Braze Insert (Male Tube X Tube SW)

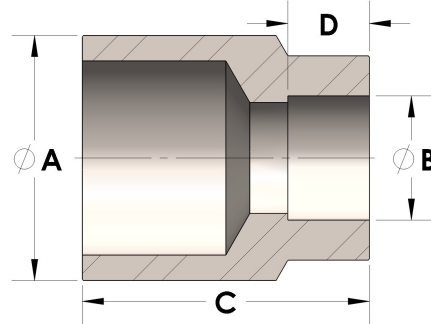

## DIMENSIONS

A	1.500
B	0.38
C	1.38
D	0.250

## GENERAL

Pressure Rating	3000 PSI
Fitting Material	316/L Stainless Steel, ASTM A276, UNS S31600/03