

Product Category

H867-24-08-M

Part Description

Direct Weld/Braze Insert (Male Tube X Tube SW)

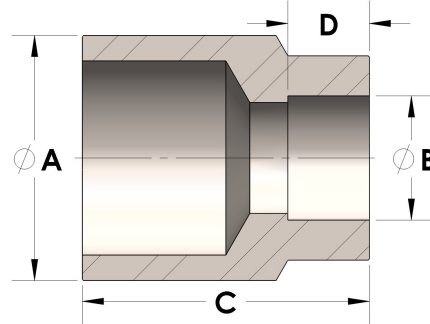

## DIMENSIONS

A	1.500
B	0.50
C	1.38
D	0.310

## GENERAL

Pressure Rating	4500 PSI
Fitting Material	Monel®, ASTM B164, UNS N04405