

Product Category

H867-24-16-M

Part Description

Direct Weld/Braze Insert (Male Tube X Tube SW)

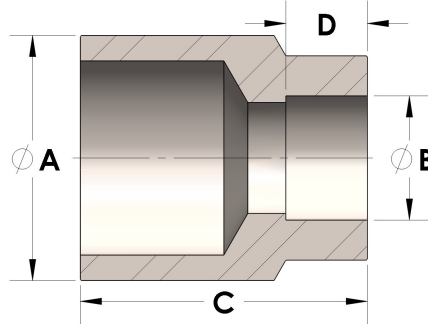

DIMENSIONS

A	1.500
B	1.00
C	1.50
D	0.500

GENERAL

Pressure Rating	4500 PSI
Fitting Material	Monel®, ASTM B164, UNS N04405