

Product Category

H867-24-16-S

Part Description

Direct Weld/Braze Insert (Male Tube X Tube SW)

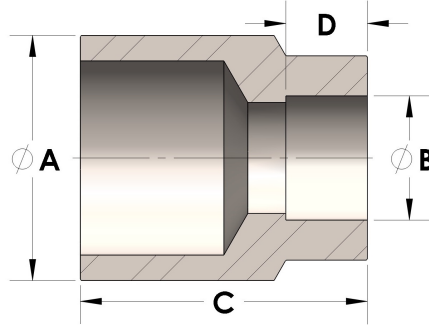

## DIMENSIONS

A	1.500
B	1.00
C	1.50
D	0.500

## GENERAL

Pressure Rating	3000 PSI
Fitting Material	Carbon Steel, ASTM A108