

Product Category

H867-24-20-SS316L

Part Description

Direct Weld/Braze Insert (Male Tube X Tube SW)

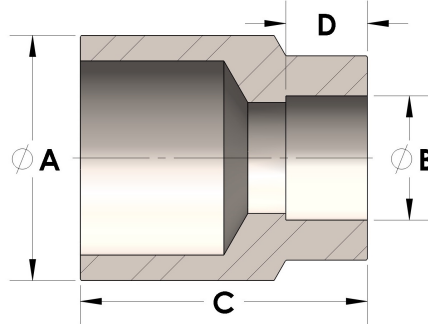

DIMENSIONS

A	1.500
B	1.25
C	1.50
D	0.560

GENERAL

Pressure Rating	4500 PSI
Fitting Material	316/L Stainless Steel, ASTM A276, UNS S31600/03