

Product Category

H867-32-24-S

Part Description

Direct Weld/Braze Insert (Male Tube X Tube SW)

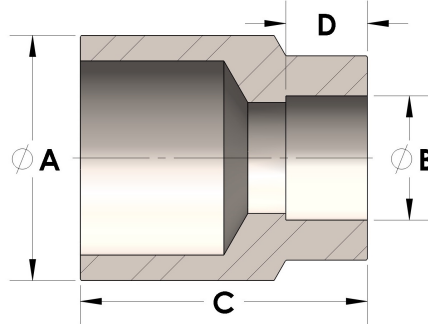

DIMENSIONS

A	2.000
B	1.50
C	1.88
D	0.630

GENERAL

Pressure Rating	4500 PSI
Fitting Material	Carbon Steel, ASTM A108